

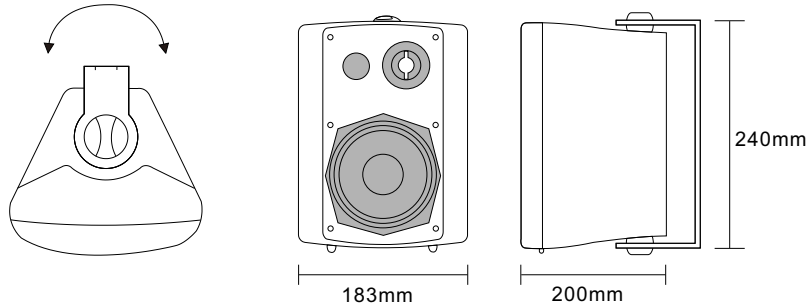

Active Wall Mount Speaker

T-775A



Model	T-775A (Black)
RMS	20W x 2 @ 8Ω
Input Sensitivity	0.5V
Frequency Response	80Hz-18KHz/1W, ±0.5dB
THD	20Hz-20KHz/1W, 0.05%
Damping Factor	>200@8Ω/400Hz
Conversion Rate	30V/US
Channel Degree of Separation	>75dB
S.N. Ratio	>95dB
Amplifier	AB class
Indication	Power and channel signal
Protection	High temp, overload, short circuit and clip
Treble Control	±10dB
Bass Control	±10dB
Input Connector	Balanced phoenix connector, dual RCA and stereo 3.5mm earphone input
AC Power Supply	~220V-240V 50/60Hz
Dimensions	183 x 200 x 240mm
Weight	4.7Kg (per pair)